

COIL - TUBE Ø 13

20,5 W

- Wire insulation class H (>185°C)
- ED. 100%
- Coil power at 20° C. 20,5 W
- Ambient temperature -20 +40° C
- Weight. 0,16 Kg

ELECTRIC CIRCUITS

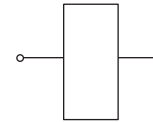

STANDARD

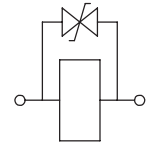

WITH DIODE
(BI-DIRECTIONAL)

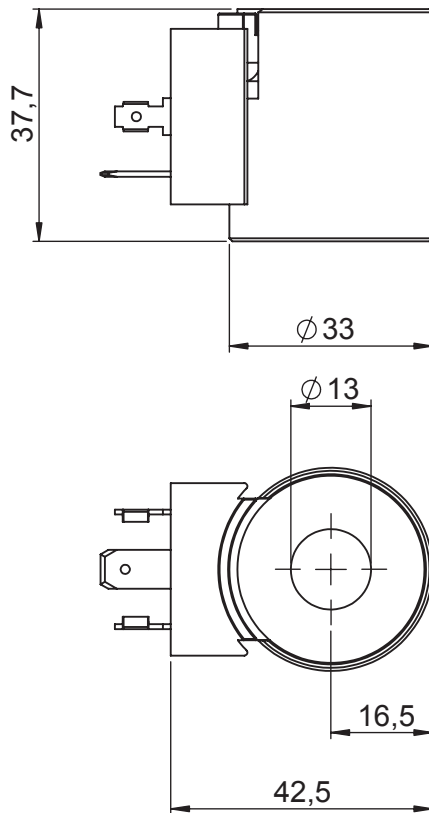

DEUTSCH DT4

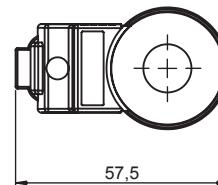
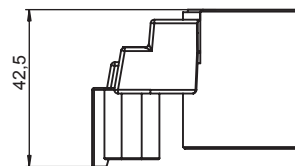

AMP - JUNIOR

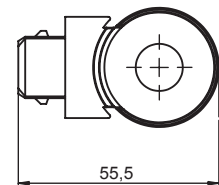
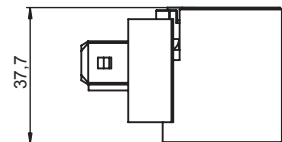

Note:

- Coil interchangeable with CT-9200 model.

CONNECTOR	PROTECTION CLASS	COIL THERMAL INSULATION CLASS	VOLTAGE [V]	RESISTANCE [Ω]	CIRCUIT	ORDERING CODE
DIN 43650	IP65*	H	12 V dc	7	STANDARD	094001000
DIN 43650	IP65*	H	24 V dc	28	STANDARD	094002000
DEUTSCH DT 4	IP67	H	12 V dc	7	WITH DIODE	094101000
DEUTSCH DT 4	IP67	H	24 V dc	28	WITH DIODE	094102000
AMP - JUNIOR	IP65*	H	12 V dc	7	STANDARD	094201000
AMP - JUNIOR	IP65*	H	24 V dc	28	STANDARD	094202000

* Protection index with standard connector

